

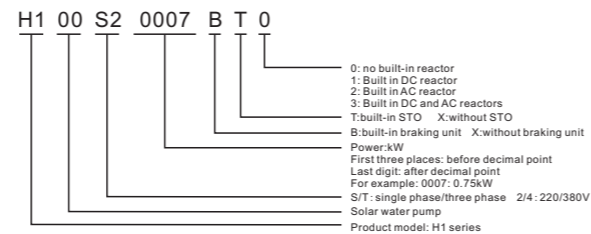

H1 Series Inverter USER MANUAL

1.2 H1 nameplate



1.3 H1 series specifications and models

Base No	Models	Input voltage	input current (A)	Power (kW)	output current (A)	Adaptive motor(kW)
F1	H100S20007BX0	1 phase 220V	8.2	0.75	5.0	0.75
	H100S20015BX0	1 phase 220V	14.0	1.5	7.0	1.5
F2	H100T20022BX0	1 phase 220V	23.0	2.2	12.5	2.2
	H100T20037BX0	3 phase 220V	13.5			
F3	H100T20055BX0	1 phase 220V	38.6	3.7	15.2	3.7
	H100T20055BX0	3 phase 220V	24			
F4	H100T20075BX0	3 phase 220V	37	7.5	31	7.5
	H100T20110BX0	3 phase 220V	52	11	45	11
F1	H100T40007BX0	3 phase 380V	4.0	0.75	3.0	0.75
	H100T40015BX0	3 phase 380V	5.8	1.5	4.5	1.5
F2	H100T40022BX0	3 phase 380V	6.5	2.2	5.6	2.2
	H100T40040BX0	3 phase 380V	12.6	4.0	10.5	4.0
F3	H100T40055BX0	3 phase 380V	16	5.5	14	5.5
	H100T40075BX0	3 phase 380V	21	7.5	19	7.5
F4	H100T40110BX0	3 phase 380V	28	11	26	11
	H100T40150BX0	3 phase 380V	36	15	33	15
F5	H100T40185BX0	3 phase 380V	42	18.5	40	18.5
	H100T40220BX0	3 phase 380V	48	22	46	22
F6	H100T40300BX0	3 phase 380V	62	30	58	30
	H100T40370BX0	3 phase 380V	76	37	75	37
F7	H100T40450XX0	3 phase 380V	92	45	90	45
	H100T40550XX0	3 phase 380V	113	55	110	55
F8	H100T40750XX0	3 phase 380V	157	75	150	75
	H100T40900XX0	3 phase 380V	180	90	170	90
F9	H100T41100XX0	3 phase 380V	214	110	210	110
	H100T41320XX0	3 phase 380V	256	132	250	132
	H100T41600XX0	3 phase 380V	307	160	300	160

NO.1 Product introduction

1. 1 Technical Features

Items	Description
input	Rated voltage/frequency: 3ph: 380V~440V, 50Hz/60Hz; 1ph: 200V~240V, 50Hz/60Hz
Allowed voltage	3ph: 320V~460V; 1ph: 180V~260V; voltage imbalance rate: <3%; frequency: ±5%
output	Voltage: 0~rated input voltage
Frequency	0Hz~1000Hz
Overload capacity	150% rated current 60s, 180% rated current 2s
control performance	Control mode: V/F, SVC
Modulation Mode	SVPWM
Motor type	asynchronous motor, synchronous motor, single phase motor (consult factory before using)
Start torque	1Hz/150%
Speed range	1:100(SVC)
Frequency accuracy	digital setting: maximum frequency±0.01%; analog setting: maximum frequency±1%
Frequency resolution	digital setting: 0.1Hz; analog setting: maximum frequency±1%
Acceleration/deceleration curve	line/ S-curve
Rapid current limit	limit current rapidly within the current protection value, to ensure the safety of the equipment
None-slip when instantaneous power off	none-stop when instantaneous power off, automatic frequency drop
Operation function	Command source: keypad, terminal, communication
Set value source	digital, analog, multi-speed, communication
PID	support main setting+PID
Operation panel	LED display: Can display: output frequency, output voltage, output current, Bus voltage, display value 1, display value 2, error, alarm
External keypad	YES
Protection function	over-current protection, over-voltage protection, under-voltage protection, overheating protection, over-load protection, phase lose protection, earth leakage, etc
Environment	Store environment: indoor, away from direct sunlight, no dust, no corrosive gas, no inflammable gas, no oil mist, no vapour, no drip and no salinity, etc
Altitude	derating use above 1000M, derating 10% per 1000M
Environment temperature	-10℃~+40℃(environment temperature around 40℃~50℃please derating use)
Humidity	5%~95%RH, no condensation
Store temperature	-40℃~+70℃
Vibration	<5.9M/S (0.6g)

NO.2 Main circuit and function card

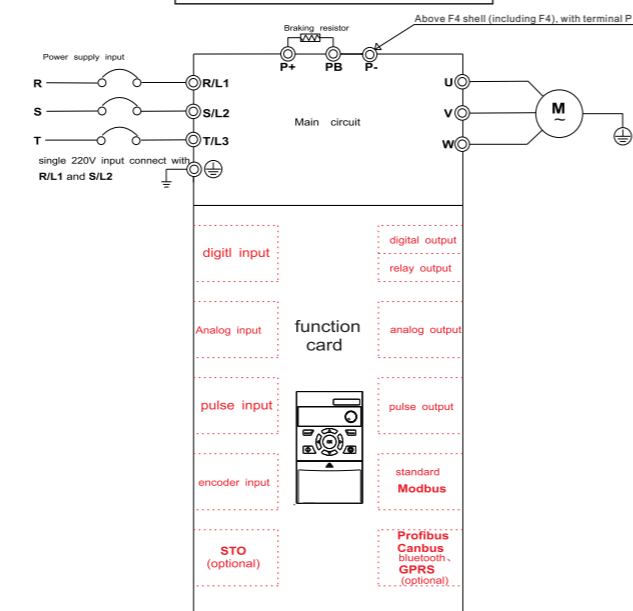

Notice: different function card corresponding to different terminals. Except standard function card, can customize any type of card. Reset parameters when using different function cards. An AC drive only can use one function card.

Warning: Do not use function card when power is on!

2. 1 Main circuit terminal description

Terminal identification	Name	Function description
⊕	Grounding terminal	Safety grounding
R/L1, S/L2, T/L3	Main circuit power input terminal	Connect three phase power supply, single phase power supply connect to R/L1, S/L2
P+, PB	Braking terminal	Connect to external braking resistor
P+, P-	DC bus terminal	Two sets or more inverters use a common DC bus (Above F4 shell (including F4), with terminal P)
U, V, W	output terminl	Connect to three phase motor

2.2 Founction card configuration table

Function card	H0100	H0101	H0102	H0103	H0104	H0110	H0120	H0130	H0131	H0200	H0201	H0300	H0310	H0320	H0350
Digital input	2	4	1	4	2	5	10	5	1	10	10		4	5	3
Digital output						1									
Relay output	1	1		3	1	2	2	2	1	3	3		1	1	1
Analog input	1	1		1	1	1	1	1		2	2		2	1	
Analog output						2	1	2		2	2		2	2	
Pulse input															
Pulse output															
Encoder input															
Modbus	1	1	1	1	1	1	optional	1	1	1	1		1	1	1
STO															
Display	Digital tube	Digital tube	Digital tube	Digital tube	Digital tube	Digital tube	Digital tube	Digital tube	Digital tube	Digital tube	Digital tube		Digital tube	Digital tube	Digital tube
Potentiometer	Analog	Analog		Analog	Analog	Analog	Analog	Analog					Analog	Analog	
Toggle switch													1	2	2
12V power supply	1			1	1	1	1	1		1	1		1		
10V power supply				1	1	1	1	1	1	1	1		1		

Note:
1. the built-in function card with STO function must be equipped with AC drive of STO circuit, for example: H0200 built-in function card is equipped with AC drive with model H100T40040BTO (the second T represents built-in STO circuit).
2. If need other types and numbers of terminals, contact the company for bulk customization

NO.3 Product Dimension

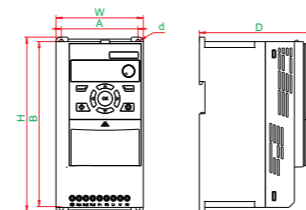

Framework	H1 series Dimensions (mm)					
	W(Width)	H(Height)	D(Depth)	A	B	d
F1	85	170	124	67.3	158	5
F2	97	194	133	85	184	5
F3	126	237	147	112	223	6
F4	168	298	160	154	283	6
F5	198	355	177	183	338	6
F6	250	400	208	230	380	7
F7	280	545	292	200	526	9
F8	380	648	299	300	626	11
F9	450	798	318	340	773	11

NO.4 Keypad description

Item	Structure	Function description
1	Display	Display
2	Program/exit	Program/exit
3	Status display interface work as status switch key; other interface work as left shift key	Status display interface work as status switch key; other interface work as left shift key
4	Reserved key	Reserved key
5	RUN	RUN
6	Potentiometer: refer to parameter P01.63	Potentiometer: refer to parameter P01.63
7	In the mode of program, work as value change key; otherwise, UP/DOWN key, refer to parameter P01.63, P02.03, P02.04	In the mode of program, work as value change key; otherwise, UP/DOWN key, refer to parameter P01.63, P02.03, P02.04
9	Enter	Enter
10	STOP/RESET	STOP/RESET
11	Customization key	Customization key

4. 2 Indicator light description

Indicator light	Status	Function description
RUN	light on/flickering	operating /decelerating
REV	light on	reverse operation
REM	light on	remote start stop
ALM	light on	fault indication
M	light on	customization indication, default alarm indication

4. 3 Display item description

Display code	Item description
F	output frequency
C	output current
U	output voltage
d	DC bus voltage
H	display value 1(P10 98)
t	display value 2(P10 99)
R	current alarm
E	current fault

NO.5 Function · Parameter Table

Function	Function	Description (setting range)	Factory default
P00.09	Parameter operation	1: parameter initialization, initialize parameters except P0.XX, in normal condition, use mode 1 in initialization; 2: initialize all parameters	0
P00.10	Setting(frequency) reference F1	0: keypad P01.63 1: multi-speed 2: AI1 3: AI2 5: communication	0
P00.11	Setting(frequency) reference F2	5: communication	0
P00.12	setting relation selection	0:F1 1:F2 2:F1+F2 3:F1-F2 4:F1*F2/100 5:maximum value(F1,F2) 6:minimum value(F1,F2) 7:average value(F1,F2) 8:PID(F1,F2) * principle interpretation: set 0 choose F1 channel setting value; set 1 choose F2 channel setting value; set 2 choose the sum of F1 and F2 channel setting value; set 3 choose the difference of F1 and F2 channel setting value; set 4 choose the product of F1 and F2 channel setting value divide 100; set 5 choose larger value of F1 and F2; set 6 choose smaller value of F1 and F2; set 7 choose average value of F1 and F2; set 8 choose PID control(F1 is setting, F2 is feedback).	0
P00.13	maximum setting value	0.000~99999.000 * principle interpretation: limit setting value range. The unit of setting source is %, the maximum setting value(P00.13) stands for 100%, take maximum setting value as standard.	50.000
P00.14	motor output frequency upper limit	~1020.000Hz~1020.000Hz interpretation: motor operation frequency upper limit	55.000Hz
P00.15	multi-speed source	0~11111111 units: S1 tens: S2 hundreds: digit: S3 thousands: digit: S4 ... * P00.15: multi-speed source, select to corresponding external terminal, multi-speed refer to P00.16-P00.23. * eg: select S2, S3, S4 as valid external terminal to control multi-speed set P00.15=1110, detailed 8 segment corresponding relationship as above table	0
P00.16	multi-speed 0		0.000%
P00.17	multi-speed 1		0.000%
P00.18	multi-speed 2	~1000.000%~1000.000%	0.000%
P00.19	multi-speed 3	function: multi-speed setting, corresponding to P00.13 maximum setting percentage	0.000%
P00.20	multi-speed 4		0.000%
P00.21	multi-speed 5		0.000%
P00.22	multi-speed 6		0.000%
P00.23	multi-speed 7		0.000%
P00.24	acceleration time	0.050s~3600.000s * principle interpretation: as figure, acceleration time refer to the time from 0Hz accelerate to P00.74 motor frequency output frequency time acceleration time deceleration time	**
P00.25	deceleration time		**
P00.26	Jog frequency	~1000.000%~1000.000% function: set jog frequency, jog command refer to P00.33	10.000%
P00.30	start command source	0: invalid 1: keypad 2: communication 3: S1 4: S2 5: S3 6: S4	1
P00.31	reverse start command source	...	0
P00.32	reverse command source	function: select command source(select keypad as command source, then reverse start command, reverse command, jog command, free stop command, safe stop command, pause command all from multi-function key of keypad)	0
P00.33	Jog command source		1
P00.34	stop command source	* reverse start command: setting value reversed, and give a start command * reverse command: setting value reversed. * jog command: jog command. Priority is higher than start command, lower than stop command.	0
P00.35	free stop command source		0
P00.36	reset command source	16 S14 S13 S12 S11 S10 S9 S8 S7 S6 7 6 5 4 3 2 1 0 S5 S4 S3 S2 S1 communication keypad invalid	1

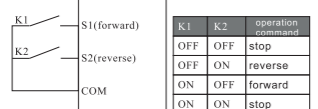
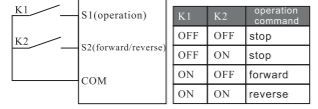
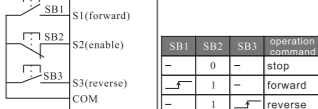
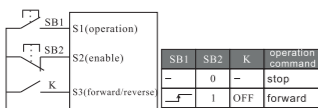
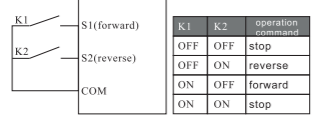
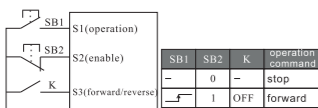
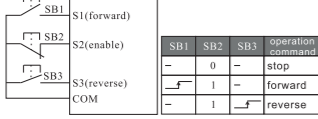
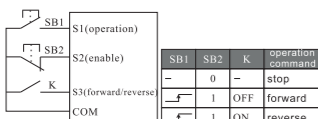
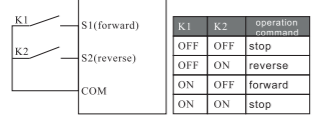
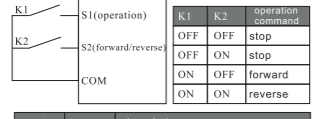
Function code	Function	Description(setting range)	Factory default																																																																																																																																						
P00.37	S1 type	<p>One place: 0: Positive logic 1: Reverse logic 2: Rising edge 3: Falling edge</p> <p>Tens place: 1: Rising edge toggle 2: Falling edge toggle</p> <p>Hundreds place: 1: The edge signal is not cleared by other edge signals</p> <p>Thousands place: 1: The edge signal is not cleared by the stop signal</p> <p>Function: select external terminal trigger type *Principle explanation: One place: 0: positive logic, High level is valid state, low level is invalid state; 1: Reverse logic, High level is invalid state, low level is valid state; 2: Rising edge, the rising edge is valid; 3: Falling edge, falling edge is valid.</p> <p>Tens place: 1: Rising edge ping-pong key; 2: Toggle on the falling edge.</p> <p>The tens position can control the edge signal and realize a reset button to control start and stop.</p> <p>Hundreds place: 1: The edge signal is not cleared by other edge signals; * P0: signal smaller than the stop signal.</p> <p>Thousands place: 1: The edge signal is not cleared by the stop signal.</p> <p>*two-line mode 1: the mode is most commonly used two-line mode, enable and direction combined, K1 and K2 control forward/reverse of motor</p>  <table border="1"> <thead> <tr> <th>K1</th> <th>K2</th> <th>operation command</th> </tr> </thead> <tbody> <tr> <td>OFF</td> <td>OFF</td> <td>stop</td> </tr> <tr> <td>OFF</td> <td>ON</td> <td>reverse</td> </tr> <tr> <td>ON</td> <td>OFF</td> <td>forward</td> </tr> <tr> <td>ON</td> <td>ON</td> <td>stop</td> </tr> </tbody> </table> <table border="1"> <thead> <tr> <th>parameter no.</th> <th>setting value</th> <th>description</th> </tr> </thead> <tbody> <tr> <td>P00.30</td> <td>3</td> <td>start command source is S1</td> </tr> <tr> <td>P00.31</td> <td>4</td> <td>reverse start command source is S2</td> </tr> <tr> <td>P00.37</td> <td>0</td> <td>S1 type is positive logic</td> </tr> <tr> <td>P00.38</td> <td>0</td> <td>S2 type is negative logic</td> </tr> </tbody> </table> <p>*two-line mode 2: enable and direction separated, in this mode K1 is enable terminal, direction is controlled by K2.</p>  <table border="1"> <thead> <tr> <th>K1</th> <th>K2</th> <th>operation command</th> </tr> </thead> <tbody> <tr> <td>OFF</td> <td>OFF</td> <td>stop</td> </tr> <tr> <td>OFF</td> <td>ON</td> <td>stop</td> </tr> <tr> <td>ON</td> <td>OFF</td> <td>forward</td> </tr> <tr> <td>ON</td> <td>ON</td> <td>reverse</td> </tr> </tbody> </table> <table border="1"> <thead> <tr> <th>parameter no.</th> <th>setting value</th> <th>description</th> </tr> </thead> <tbody> <tr> <td>P00.30</td> <td>3</td> <td>start command source is S1</td> </tr> <tr> <td>P00.32</td> <td>4</td> <td>reverse command source is S2</td> </tr> <tr> <td>P00.37</td> <td>0</td> <td>S1 type is positive logic</td> </tr> <tr> <td>P00.38</td> <td>0</td> <td>S2 type is positive logic</td> </tr> </tbody> </table> <p>*three line mode 1: this mode define SB2 as enable terminal, operation command is generated by SB1 or SB3, control operation direction at the same time. inverter is running and SB2 is in closed state, terminal SB1 or SB3 generates a rising edge signal to control inverter operation and direction; disconnection SB2 to stop inverter.</p>  <table border="1"> <thead> <tr> <th>SB1</th> <th>SB2</th> <th>SB3</th> <th>operation command</th> </tr> </thead> <tbody> <tr> <td>-</td> <td>0</td> <td>-</td> <td>stop</td> </tr> <tr> <td>-</td> <td>1</td> <td>-</td> <td>forward</td> </tr> <tr> <td>-</td> <td>1</td> <td>1</td> <td>reverse</td> </tr> </tbody> </table> <table border="1"> <thead> <tr> <th>parameter no.</th> <th>setting value</th> <th>description</th> </tr> </thead> <tbody> <tr> <td>P00.30</td> <td>3</td> <td>start command source is S1</td> </tr> <tr> <td>P00.31</td> <td>5</td> <td>reverse start command source is S3</td> </tr> <tr> <td>P00.34</td> <td>4</td> <td>stop command source is S2</td> </tr> <tr> <td>P00.37</td> <td>2</td> <td>S1 type is rising edge</td> </tr> <tr> <td>P00.38</td> <td>1</td> <td>S2 type is negative logic</td> </tr> <tr> <td>P00.39</td> <td>2</td> <td>S3 type is rising edge</td> </tr> </tbody> </table> <p>*three line mode 2: this mode define SB2 as enable terminal, operation command is generated by SB1, direction command is controlled by K. inverter is running and SB2 is in closed state, terminal B1 generates a rising edge signal to control inverter operation, K control operation direction; disconnection SB2 to stop inverter.</p>  <table border="1"> <thead> <tr> <th>SB1</th> <th>SB2</th> <th>K</th> <th>operation command</th> </tr> </thead> <tbody> <tr> <td>-</td> <td>0</td> <td>-</td> <td>stop</td> </tr> <tr> <td>-</td> <td>1</td> <td>OFF</td> <td>forward</td> </tr> <tr> <td>-</td> <td>1</td> <td>ON</td> <td>reverse</td> </tr> </tbody> </table> <table border="1"> <thead> <tr> <th>parameter no.</th> <th>setting value</th> <th>description</th> </tr> </thead> <tbody> <tr> <td>P00.30</td> <td>3</td> <td>start command source is S1</td> </tr> <tr> <td>P00.32</td> <td>5</td> <td>reverse command source is S3</td> </tr> <tr> <td>P00.34</td> <td>4</td> <td>stop command source is S2</td> </tr> <tr> <td>P00.37</td> <td>2</td> <td>S1 terminal command type is rising edge</td> </tr> <tr> <td>P00.38</td> <td>1</td> <td>S2 terminal command type is negative logic</td> </tr> <tr> <td>P00.39</td> <td>0</td> <td>S3 terminal command type is positive logic</td> </tr> </tbody> </table>	K1	K2	operation command	OFF	OFF	stop	OFF	ON	reverse	ON	OFF	forward	ON	ON	stop	parameter no.	setting value	description	P00.30	3	start command source is S1	P00.31	4	reverse start command source is S2	P00.37	0	S1 type is positive logic	P00.38	0	S2 type is negative logic	K1	K2	operation command	OFF	OFF	stop	OFF	ON	stop	ON	OFF	forward	ON	ON	reverse	parameter no.	setting value	description	P00.30	3	start command source is S1	P00.32	4	reverse command source is S2	P00.37	0	S1 type is positive logic	P00.38	0	S2 type is positive logic	SB1	SB2	SB3	operation command	-	0	-	stop	-	1	-	forward	-	1	1	reverse	parameter no.	setting value	description	P00.30	3	start command source is S1	P00.31	5	reverse start command source is S3	P00.34	4	stop command source is S2	P00.37	2	S1 type is rising edge	P00.38	1	S2 type is negative logic	P00.39	2	S3 type is rising edge	SB1	SB2	K	operation command	-	0	-	stop	-	1	OFF	forward	-	1	ON	reverse	parameter no.	setting value	description	P00.30	3	start command source is S1	P00.32	5	reverse command source is S3	P00.34	4	stop command source is S2	P00.37	2	S1 terminal command type is rising edge	P00.38	1	S2 terminal command type is negative logic	P00.39	0	S3 terminal command type is positive logic	0
K1	K2	operation command																																																																																																																																							
OFF	OFF	stop																																																																																																																																							
OFF	ON	reverse																																																																																																																																							
ON	OFF	forward																																																																																																																																							
ON	ON	stop																																																																																																																																							
parameter no.	setting value	description																																																																																																																																							
P00.30	3	start command source is S1																																																																																																																																							
P00.31	4	reverse start command source is S2																																																																																																																																							
P00.37	0	S1 type is positive logic																																																																																																																																							
P00.38	0	S2 type is negative logic																																																																																																																																							
K1	K2	operation command																																																																																																																																							
OFF	OFF	stop																																																																																																																																							
OFF	ON	stop																																																																																																																																							
ON	OFF	forward																																																																																																																																							
ON	ON	reverse																																																																																																																																							
parameter no.	setting value	description																																																																																																																																							
P00.30	3	start command source is S1																																																																																																																																							
P00.32	4	reverse command source is S2																																																																																																																																							
P00.37	0	S1 type is positive logic																																																																																																																																							
P00.38	0	S2 type is positive logic																																																																																																																																							
SB1	SB2	SB3	operation command																																																																																																																																						
-	0	-	stop																																																																																																																																						
-	1	-	forward																																																																																																																																						
-	1	1	reverse																																																																																																																																						
parameter no.	setting value	description																																																																																																																																							
P00.30	3	start command source is S1																																																																																																																																							
P00.31	5	reverse start command source is S3																																																																																																																																							
P00.34	4	stop command source is S2																																																																																																																																							
P00.37	2	S1 type is rising edge																																																																																																																																							
P00.38	1	S2 type is negative logic																																																																																																																																							
P00.39	2	S3 type is rising edge																																																																																																																																							
SB1	SB2	K	operation command																																																																																																																																						
-	0	-	stop																																																																																																																																						
-	1	OFF	forward																																																																																																																																						
-	1	ON	reverse																																																																																																																																						
parameter no.	setting value	description																																																																																																																																							
P00.30	3	start command source is S1																																																																																																																																							
P00.32	5	reverse command source is S3																																																																																																																																							
P00.34	4	stop command source is S2																																																																																																																																							
P00.37	2	S1 terminal command type is rising edge																																																																																																																																							
P00.38	1	S2 terminal command type is negative logic																																																																																																																																							
P00.39	0	S3 terminal command type is positive logic																																																																																																																																							
P00.38	S2 type	<p>One place: 0: Positive logic 1: Reverse logic 2: Rising edge 3: Falling edge</p> <p>Tens place: 1: Rising edge toggle 2: Falling edge toggle</p> <p>Hundreds place: 1: The edge signal is not cleared by other edge signals</p> <p>Thousands place: 1: The edge signal is not cleared by the stop signal</p> <p>Function: select external terminal trigger type *Principle explanation: One place: 0: positive logic, High level is valid state, low level is invalid state; 1: Reverse logic, High level is invalid state, low level is valid state; 2: Rising edge, the rising edge is valid; 3: Falling edge, falling edge is valid.</p> <p>Tens place: 1: Rising edge ping-pong key; 2: Toggle on the falling edge.</p> <p>The tens position can control the edge signal and realize a reset button to control start and stop.</p> <p>Hundreds place: 1: The edge signal is not cleared by other edge signals; * P0: signal smaller than the stop signal.</p> <p>Thousands place: 1: The edge signal is not cleared by the stop signal.</p> <p>*two-line mode 1: the mode is most commonly used two-line mode, enable and direction combined, K1 and K2 control forward/reverse of motor</p>  <table border="1"> <thead> <tr> <th>K1</th> <th>K2</th> <th>operation command</th> </tr> </thead> <tbody> <tr> <td>OFF</td> <td>OFF</td> <td>stop</td> </tr> <tr> <td>OFF</td> <td>ON</td> <td>reverse</td> </tr> <tr> <td>ON</td> <td>OFF</td> <td>forward</td> </tr> <tr> <td>ON</td> <td>ON</td> <td>stop</td> </tr> </tbody> </table> <table border="1"> <thead> <tr> <th>parameter no.</th> <th>setting value</th> <th>description</th> </tr> </thead> <tbody> <tr> <td>P00.30</td> <td>3</td> <td>start command source is S1</td> </tr> <tr> <td>P00.31</td> <td>4</td> <td>reverse start command source is S2</td> </tr> <tr> <td>P00.37</td> <td>0</td> <td>S1 type is positive logic</td> </tr> <tr> <td>P00.38</td> <td>0</td> <td>S2 type is positive logic</td> </tr> </tbody> </table> <p>*two-line mode 2: enable and direction separated, in this mode K1 is enable terminal, direction is controlled by K2.</p>  <table border="1"> <thead> <tr> <th>K1</th> <th>K2</th> <th>operation command</th> </tr> </thead> <tbody> <tr> <td>OFF</td> <td>OFF</td> <td>stop</td> </tr> <tr> <td>OFF</td> <td>ON</td> <td>stop</td> </tr> <tr> <td>ON</td> <td>OFF</td> <td>forward</td> </tr> <tr> <td>ON</td> <td>ON</td> <td>reverse</td> </tr> </tbody> </table> <table border="1"> <thead> <tr> <th>parameter no.</th> <th>setting value</th> <th>description</th> </tr> </thead> <tbody> <tr> <td>P00.30</td> <td>3</td> <td>start command source is S1</td> </tr> <tr> <td>P00.32</td> <td>4</td> <td>reverse command source is S2</td> </tr> <tr> <td>P00.37</td> <td>0</td> <td>S1 type is positive logic</td> </tr> <tr> <td>P00.38</td> <td>0</td> <td>S2 type is positive logic</td> </tr> </tbody> </table> <p>*three line mode 1: this mode define SB2 as enable terminal, operation command is generated by SB1 or SB3, control operation direction at the same time. inverter is running and SB2 is in closed state, terminal SB1 or SB3 generates a rising edge signal to control inverter operation and direction; disconnection SB2 to stop inverter.</p>  <table border="1"> <thead> <tr> <th>SB1</th> <th>SB2</th> <th>SB3</th> <th>operation command</th> </tr> </thead> <tbody> <tr> <td>-</td> <td>0</td> <td>-</td> <td>stop</td> </tr> <tr> <td>-</td> <td>1</td> <td>-</td> <td>forward</td> </tr> <tr> <td>-</td> <td>1</td> <td>1</td> <td>reverse</td> </tr> </tbody> </table> <table border="1"> <thead> <tr> <th>parameter no.</th> <th>setting value</th> <th>description</th> </tr> </thead> <tbody> <tr> <td>P00.30</td> <td>3</td> <td>start command source is S1</td> </tr> <tr> <td>P00.31</td> <td>5</td> <td>reverse start command source is S3</td> </tr> <tr> <td>P00.34</td> <td>4</td> <td>stop command source is S2</td> </tr> <tr> <td>P00.37</td> <td>2</td> <td>S1 type is rising edge</td> </tr> <tr> <td>P00.38</td> <td>1</td> <td>S2 type is negative logic</td> </tr> <tr> <td>P00.39</td> <td>2</td> <td>S3 type is rising edge</td> </tr> </tbody> </table> <p>*three line mode 2: this mode define SB2 as enable terminal, operation command is generated by SB1, direction command is controlled by K. inverter is running and SB2 is in closed state, terminal B1 generates a rising edge signal to control inverter operation, K control operation direction; disconnection SB2 to stop inverter.</p>  <table border="1"> <thead> <tr> <th>SB1</th> <th>SB2</th> <th>K</th> <th>operation command</th> </tr> </thead> <tbody> <tr> <td>-</td> <td>0</td> <td>-</td> <td>stop</td> </tr> <tr> <td>-</td> <td>1</td> <td>OFF</td> <td>forward</td> </tr> <tr> <td>-</td> <td>1</td> <td>ON</td> <td>reverse</td> </tr> </tbody> </table> <table border="1"> <thead> <tr> <th>parameter no.</th> <th>setting value</th> <th>description</th> </tr> </thead> <tbody> <tr> <td>P00.30</td> <td>3</td> <td>start command source is S1</td> </tr> <tr> <td>P00.32</td> <td>5</td> <td>reverse command source is S3</td> </tr> <tr> <td>P00.34</td> <td>4</td> <td>stop command source is S2</td> </tr> <tr> <td>P00.37</td> <td>2</td> <td>S1 terminal command type is rising edge</td> </tr> <tr> <td>P00.38</td> <td>1</td> <td>S2 terminal command type is negative logic</td> </tr> <tr> <td>P00.39</td> <td>0</td> <td>S3 terminal command type is positive logic</td> </tr> </tbody> </table>	K1	K2	operation command	OFF	OFF	stop	OFF	ON	reverse	ON	OFF	forward	ON	ON	stop	parameter no.	setting value	description	P00.30	3	start command source is S1	P00.31	4	reverse start command source is S2	P00.37	0	S1 type is positive logic	P00.38	0	S2 type is positive logic	K1	K2	operation command	OFF	OFF	stop	OFF	ON	stop	ON	OFF	forward	ON	ON	reverse	parameter no.	setting value	description	P00.30	3	start command source is S1	P00.32	4	reverse command source is S2	P00.37	0	S1 type is positive logic	P00.38	0	S2 type is positive logic	SB1	SB2	SB3	operation command	-	0	-	stop	-	1	-	forward	-	1	1	reverse	parameter no.	setting value	description	P00.30	3	start command source is S1	P00.31	5	reverse start command source is S3	P00.34	4	stop command source is S2	P00.37	2	S1 type is rising edge	P00.38	1	S2 type is negative logic	P00.39	2	S3 type is rising edge	SB1	SB2	K	operation command	-	0	-	stop	-	1	OFF	forward	-	1	ON	reverse	parameter no.	setting value	description	P00.30	3	start command source is S1	P00.32	5	reverse command source is S3	P00.34	4	stop command source is S2	P00.37	2	S1 terminal command type is rising edge	P00.38	1	S2 terminal command type is negative logic	P00.39	0	S3 terminal command type is positive logic	0
K1	K2	operation command																																																																																																																																							
OFF	OFF	stop																																																																																																																																							
OFF	ON	reverse																																																																																																																																							
ON	OFF	forward																																																																																																																																							
ON	ON	stop																																																																																																																																							
parameter no.	setting value	description																																																																																																																																							
P00.30	3	start command source is S1																																																																																																																																							
P00.31	4	reverse start command source is S2																																																																																																																																							
P00.37	0	S1 type is positive logic																																																																																																																																							
P00.38	0	S2 type is positive logic																																																																																																																																							
K1	K2	operation command																																																																																																																																							
OFF	OFF	stop																																																																																																																																							
OFF	ON	stop																																																																																																																																							
ON	OFF	forward																																																																																																																																							
ON	ON	reverse																																																																																																																																							
parameter no.	setting value	description																																																																																																																																							
P00.30	3	start command source is S1																																																																																																																																							
P00.32	4	reverse command source is S2																																																																																																																																							
P00.37	0	S1 type is positive logic																																																																																																																																							
P00.38	0	S2 type is positive logic																																																																																																																																							
SB1	SB2	SB3	operation command																																																																																																																																						
-	0	-	stop																																																																																																																																						
-	1	-	forward																																																																																																																																						
-	1	1	reverse																																																																																																																																						
parameter no.	setting value	description																																																																																																																																							
P00.30	3	start command source is S1																																																																																																																																							
P00.31	5	reverse start command source is S3																																																																																																																																							
P00.34	4	stop command source is S2																																																																																																																																							
P00.37	2	S1 type is rising edge																																																																																																																																							
P00.38	1	S2 type is negative logic																																																																																																																																							
P00.39	2	S3 type is rising edge																																																																																																																																							
SB1	SB2	K	operation command																																																																																																																																						
-	0	-	stop																																																																																																																																						
-	1	OFF	forward																																																																																																																																						
-	1	ON	reverse																																																																																																																																						
parameter no.	setting value	description																																																																																																																																							
P00.30	3	start command source is S1																																																																																																																																							
P00.32	5	reverse command source is S3																																																																																																																																							
P00.34	4	stop command source is S2																																																																																																																																							
P00.37	2	S1 terminal command type is rising edge																																																																																																																																							
P00.38	1	S2 terminal command type is negative logic																																																																																																																																							
P00.39	0	S3 terminal command type is positive logic																																																																																																																																							
P00.39	S3 type	<p>One place: 0: Positive logic 1: Reverse logic 2: Rising edge 3: Falling edge</p> <p>Tens place: 1: Rising edge toggle 2: Falling edge toggle</p> <p>Hundreds place: 1: The edge signal is not cleared by other edge signals</p> <p>Thousands place: 1: The edge signal is not cleared by the stop signal</p> <p>Function: select external terminal trigger type *Principle explanation: One place: 0: positive logic, High level is valid state, low level is invalid state; 1: Reverse logic, High level is invalid state, low level is valid state; 2: Rising edge, the rising edge is valid; 3: Falling edge, falling edge is valid.</p> <p>Tens place: 1: Rising edge ping-pong key; 2: Toggle on the falling edge.</p> <p>The tens position can control the edge signal and realize a reset button to control start and stop.</p> <p>Hundreds place: 1: The edge signal is not cleared by other edge signals; * P0: signal smaller than the stop signal.</p> <p>Thousands place: 1: The edge signal is not cleared by the stop signal.</p> <p>*two-line mode 1: the mode is most commonly used two-line mode, enable and direction combined, K1 and K2 control forward/reverse of motor</p>  <table border="1"> <thead> <tr> <th>K1</th> <th>K2</th> <th>operation command</th> </tr> </thead> <tbody> <tr> <td>OFF</td> <td>OFF</td> <td>stop</td> </tr> <tr> <td>OFF</td> <td>ON</td> <td>reverse</td> </tr> <tr> <td>ON</td> <td>OFF</td> <td>forward</td> </tr> <tr> <td>ON</td> <td>ON</td> <td>stop</td> </tr> </tbody> </table> <table border="1"> <thead> <tr> <th>parameter no.</th> <th>setting value</th> <th>description</th> </tr> </thead> <tbody> <tr> <td>P00.30</td> <td>3</td> <td>start command source is S1</td> </tr> <tr> <td>P00.31</td> <td>5</td> <td>reverse start command source is S3</td> </tr> <tr> <td>P00.34</td> <td>4</td> <td>stop command source is S2</td> </tr> <tr> <td>P00.37</td> <td>2</td> <td>S1 type is rising edge</td> </tr> <tr> <td>P00.38</td> <td>1</td> <td>S2 type is negative logic</td> </tr> <tr> <td>P00.39</td> <td>2</td> <td>S3 type is rising edge</td> </tr> </tbody> </table> <p>*two-line mode 2: enable and direction separated, in this mode K1 is enable terminal, direction is controlled by K2.</p>  <table border="1"> <thead> <tr> <th>K1</th> <th>K2</th> <th>operation command</th> </tr> </thead> <tbody> <tr> <td>OFF</td> <td>OFF</td> <td>stop</td> </tr> <tr> <td>OFF</td> <td>ON</td> <td>stop</td> </tr> <tr> <td>ON</td> <td>OFF</td> <td>forward</td> </tr> <tr> <td>ON</td> <td>ON</td> <td>reverse</td> </tr> </tbody> </table> <table border="1"> <thead> <tr> <th>parameter no.</th> <th>setting value</th> <th>description</th> </tr> </thead> <tbody> <tr> <td>P00.30</td> <td>3</td> <td>start command source is S1</td> </tr> <tr> <td>P00.32</td> <td>5</td> <td>reverse command source is S3</td> </tr> <tr> <td>P00.34</td> <td>4</td> <td>stop command source is S2</td> </tr> <tr> <td>P00.37</td> <td>2</td> <td>S1 terminal command type is rising edge</td> </tr> <tr> <td>P00.38</td> <td>1</td> <td>S2 terminal command type is negative logic</td> </tr> <tr> <td>P00.39</td> <td>0</td> <td>S3 terminal command type is positive logic</td> </tr> </tbody> </table>	K1	K2	operation command	OFF	OFF	stop	OFF	ON	reverse	ON	OFF	forward	ON	ON	stop	parameter no.	setting value	description	P00.30	3	start command source is S1	P00.31	5	reverse start command source is S3	P00.34	4	stop command source is S2	P00.37	2	S1 type is rising edge	P00.38	1	S2 type is negative logic	P00.39	2	S3 type is rising edge	K1	K2	operation command	OFF	OFF	stop	OFF	ON	stop	ON	OFF	forward	ON	ON	reverse	parameter no.	setting value	description	P00.30	3	start command source is S1	P00.32	5	reverse command source is S3	P00.34	4	stop command source is S2	P00.37	2	S1 terminal command type is rising edge	P00.38	1	S2 terminal command type is negative logic	P00.39	0	S3 terminal command type is positive logic	0																																																														
K1	K2	operation command																																																																																																																																							
OFF	OFF	stop																																																																																																																																							
OFF	ON	reverse																																																																																																																																							
ON	OFF	forward																																																																																																																																							
ON	ON	stop																																																																																																																																							
parameter no.	setting value	description																																																																																																																																							
P00.30	3	start command source is S1																																																																																																																																							
P00.31	5	reverse start command source is S3																																																																																																																																							
P00.34	4	stop command source is S2																																																																																																																																							
P00.37	2	S1 type is rising edge																																																																																																																																							
P00.38	1	S2 type is negative logic																																																																																																																																							
P00.39	2	S3 type is rising edge																																																																																																																																							
K1	K2	operation command																																																																																																																																							
OFF	OFF	stop																																																																																																																																							
OFF	ON	stop																																																																																																																																							
ON	OFF	forward																																																																																																																																							
ON	ON	reverse																																																																																																																																							
parameter no.	setting value	description																																																																																																																																							
P00.30	3	start command source is S1																																																																																																																																							
P00.32	5	reverse command source is S3																																																																																																																																							
P00.34	4	stop command source is S2																																																																																																																																							
P00.37	2	S1 terminal command type is rising edge																																																																																																																																							
P00.38	1	S2 terminal command type is negative logic																																																																																																																																							
P00.39	0	S3 terminal command type is positive logic																																																																																																																																							
P00.40	Y1 terminal source	<p>0:always 0 1:always 1 2:stopped 3:running 4:alarm 5:alarm 6:reversing 64:STO status 100-9999:high level parameter</p> <p>* principal interpretation: terminal source setting value >=100 (address mode), the address is selected parameter no., actual value is decided by current value of selected parameter no. terminal source function description as below:</p> <table border="1"> <thead> <tr> <th>setting value</th> <th>function</th> <th>description</th> </tr> </thead> <tbody> <tr> <td>0</td> <td>always 0</td> <td>Y1 terminal output always 0</td> </tr> <tr> <td>1</td> <td>always 1</td> <td>Y1 terminal output always 1</td> </tr> <tr> <td>2</td> <td>stopped</td> <td>in stopped status Y1 terminal output is 1</td> </tr> <tr> <td>3</td> <td>running</td> <td>in running status Y1 terminal output is 1</td> </tr> <tr> <td>4</td> <td>fault</td> <td>in fault status Y1 terminal output is 1</td> </tr> <tr> <td>5</td> <td>alarm</td> <td>in alarm status Y1 terminal output is 1</td> </tr> <tr> <td>6</td> <td>reversing</td> <td>in reversing status Y1 terminal output is 1</td> </tr> <tr> <td>64</td> <td>STO status</td> <td>in STO status Y1 terminal output is 1</td> </tr> <tr> <td>100-9999</td> <td>high level parameter</td> <td></td> </tr> </tbody> </table>	setting value	function	description	0	always 0	Y1 terminal output always 0	1	always 1	Y1 terminal output always 1	2	stopped	in stopped status Y1 terminal output is 1	3	running	in running status Y1 terminal output is 1	4	fault	in fault status Y1 terminal output is 1	5	alarm	in alarm status Y1 terminal output is 1	6	reversing	in reversing status Y1 terminal output is 1	64	STO status	in STO status Y1 terminal output is 1	100-9999	high level parameter		3																																																																																																								
setting value	function	description																																																																																																																																							
0	always 0	Y1 terminal output always 0																																																																																																																																							
1	always 1	Y1 terminal output always 1																																																																																																																																							
2	stopped	in stopped status Y1 terminal output is 1																																																																																																																																							
3	running	in running status Y1 terminal output is 1																																																																																																																																							
4	fault	in fault status Y1 terminal output is 1																																																																																																																																							
5	alarm	in alarm status Y1 terminal output is 1																																																																																																																																							
6	reversing	in reversing status Y1 terminal output is 1																																																																																																																																							
64	STO status	in STO status Y1 terminal output is 1																																																																																																																																							
100-9999	high level parameter																																																																																																																																								

Function code	Function	Description(setting range)	Factory default																																																																								
P00.41	A11 low side voltage(current)	- 999999.000-999999.000 function: analog input A11 setting *A11 low side voltage(current): set the lowest voltage(current) of input signal. *A11 high side voltage(current): set the highest voltage(current) of input signal.	0.000V(mA)																																																																								
P00.42	A11 high side voltage(current)	*A11 low side setting: set corresponding value of low side voltage(current). *A11 high side setting: set corresponding value of high side voltage(current).	10.000V(mA)																																																																								
P00.43	A11 low side setting	range setting A11 high side setting A11 terminal setting A11 low side setting P00.43	0.000%																																																																								
P00.44	A11 high side setting	A11 high side setting A11 terminal setting A11 low side setting P00.43	100.000%																																																																								
P00.45	AO1 signal source	0:always 0 1:always 10V/20mA 2:output frequency 3:motor current 4:output voltage 5:motor torque 6:output power 7:setting frequency 100-9999:high level parameter ** principal interpretation: AO1 signal source function description as below:	2																																																																								
		<table border="1"> <thead> <tr> <th>setting value</th> <th>function</th> <th>description</th> </tr> </thead> <tbody> <tr> <td>0</td> <td>always 0</td> <td>analog AO1 output always 0</td> </tr> <tr> <td>1</td> <td>always 10V/20mA</td> <td>analog AO1 output always 1</td> </tr> <tr> <td>2</td> <td>output frequency</td> <td>analog AO1 output is output frequency</td> </tr> <tr> <td>3</td> <td>motor current</td> <td>analog AO1 output is motor current</td> </tr> <tr> <td>4</td> <td>output voltage</td> <td>analog AO1 output is output voltage</td> </tr> <tr> <td>5</td> <td>motor torque</td> <td>analog AO1 output is motor torque</td> </tr> <tr> <td>6</td> <td>output power</td> <td>analog AO1 output is output power</td> </tr> <tr> <td>7</td> <td>setting frequency</td> <td>analog AO1 output is setting frequency</td> </tr> <tr> <td>100-9999</td> <td>high level parameter</td> <td></td> </tr> </tbody> </table>	setting value	function	description	0	always 0	analog AO1 output always 0	1	always 10V/20mA	analog AO1 output always 1	2	output frequency	analog AO1 output is output frequency	3	motor current	analog AO1 output is motor current	4	output voltage	analog AO1 output is output voltage	5	motor torque	analog AO1 output is motor torque	6	output power	analog AO1 output is output power	7	setting frequency	analog AO1 output is setting frequency	100-9999	high level parameter																																												
setting value	function	description																																																																									
0	always 0	analog AO1 output always 0																																																																									
1	always 10V/20mA	analog AO1 output always 1																																																																									
2	output frequency	analog AO1 output is output frequency																																																																									
3	motor current	analog AO1 output is motor current																																																																									
4	output voltage	analog AO1 output is output voltage																																																																									
5	motor torque	analog AO1 output is motor torque																																																																									
6	output power	analog AO1 output is output power																																																																									
7	setting frequency	analog AO1 output is setting frequency																																																																									
100-9999	high level parameter																																																																										
P00.46	AO1 low side setting	- 999999.000-999999.000 * AO1 low side setting: set AO1 source minimum value. * AO1 high side setting: set AO1 source maximum value. * AO1 low side voltage(current): set the lowest voltage(current) of output signal. * AO1 high side voltage(current): set the highest voltage(current) of output signal.	0.000																																																																								
P00.47	AO1 high side setting		50.000																																																																								
P00.48	AO1 low side voltage(current)	range setting P00.49 AO1 high side voltage setting P00.48 AO1 low side voltage setting P00.46 AO1 low side setting P00.45 AO1 signal source P00.47 AO1 high side setting	0.000V(mA)																																																																								
P00.49	AO1 high side voltage(current)		10.000V(mA)																																																																								
P00.50	PID proportional gain	0.000%-10.000% Determine the adjustment intensity of the whole PID regulator, bigger proportional gain is, bigger adjustment intensity is.	0.010%																																																																								
P00.51	PID integral gain	0.001s-9999.000s Determine PID regulator to the integral speed adjustment of the division of PID feedback quantity and given quantity, smaller integral gain is, greater adjustment intensity is.	10.000s																																																																								
P00.52	PID output upper limit	-1000.000%-1000.000% PID adjust the output maximum value, if higher than maximum value, then output PID output upper limit, relative to P0.11 maximum setting value percentage.	100.000%																																																																								
P00.53	PID output lower limit	-1000.000%-1000.000% PID adjust the output minimum value, if lower than minimum value, then output PID output lower limit, relative to P0.11 maximum setting value percentage.	0.000%																																																																								
P00.54	PID range	0.001%-9999.000% set according to actual feedback value, if lower than feedback value, then PID invalid.	100.000																																																																								
P00.55	PID dormancy frequency	0.000%-500.000% set dormancy accurate frequency, relative to P0.11 maximum setting value percentage.	0.000%																																																																								
P00.56	PID enter dormancy time	0.000s-3600.000s inverter reach enter dormancy time and meet to dormancy time, enter dormancy.	0.000s																																																																								
P00.57	PID wakeup deviation	0.000%-100.000% percentage based on setting value.	0.000%																																																																								
P00.58	PID enter wakeup time	0.000s-3600.000s inverter reach wakeup deviation and meet to wakeup time, operation again.	0.000s																																																																								
P00.59	PID dormancy action	0: no dormancy; 1: PID stop; 2: decelerate to stop; 3: free stop; 4: pause; 5: operate in lowest frequency; PID enter dormancy according to setting dormancy action.	0																																																																								
		pressure sensor range: 1.6MPa(1MPa-10kg)PID control parameter																																																																									
		<table border="1"> <thead> <tr> <th>parameter</th> <th>parameter name</th> <th>range</th> <th>description</th> </tr> </thead> <tbody> <tr> <td>P01.63</td> <td>keyboard setting source</td> <td>0</td> <td>digital keypad(P02.92)setting</td> </tr> <tr> <td>P02.92</td> <td>setting value</td> <td>10</td> <td>PID digital keypad set time</td> </tr> <tr> <td>P00.11</td> <td>feedback value</td> <td>2</td> <td>PID analog A11 feedback</td> </tr> <tr> <td>P00.12</td> <td>setting relationship selector</td> <td>8</td> <td>PID enable</td> </tr> <tr> <td>P00.44</td> <td>A11 high side setting</td> <td>16</td> <td>A11 high side set 16kg (0-10V corresponding to 0-16kg)</td> </tr> <tr> <td>P00.50</td> <td>PID proportional gain</td> <td>0.01%</td> <td>According to field adjustment (use PID dormancy parameter)</td> </tr> <tr> <td>P00.51</td> <td>PID integral gain</td> <td>10s</td> <td>According to field adjustment (use PID dormancy parameter)</td> </tr> <tr> <td>P00.54</td> <td>PID range</td> <td>16</td> <td>PID set feedback range 16kg</td> </tr> <tr> <td>P00.55</td> <td>PID dormancy frequency</td> <td>10%</td> <td>PID dormancy frequency set 5Hz (maximum default setting value 5Hz)</td> </tr> <tr> <td>P00.56</td> <td>PID dormancy time</td> <td>5s</td> <td>PID dormancy time 5s</td> </tr> <tr> <td>P00.57</td> <td>PID wakeup deviation</td> <td>20%</td> <td>PID wakeup deviation 20%</td> </tr> <tr> <td>P00.58</td> <td>PID enter wakeup time</td> <td>10s</td> <td>PID wakeup time 10s</td> </tr> <tr> <td>P00.59</td> <td>PID dormancy action</td> <td>2</td> <td>PID dormancy action set 0: no dormancy</td> </tr> <tr> <td>P01.68</td> <td>display value 1 source</td> <td>1090</td> <td>keyboard display PID setting pressure</td> </tr> <tr> <td>P01.69</td> <td>display value 2 source</td> <td>1091</td> <td>keyboard display PID feedback pressure</td> </tr> <tr> <td>P02.03</td> <td>UPI command source</td> <td>1</td> <td>(UP) command from keyboard</td> </tr> <tr> <td>P02.04</td> <td>DOWN command source</td> <td>1</td> <td>(DOWN) command from keyboard</td> </tr> </tbody> </table>	parameter	parameter name	range	description	P01.63	keyboard setting source	0	digital keypad(P02.92)setting	P02.92	setting value	10	PID digital keypad set time	P00.11	feedback value	2	PID analog A11 feedback	P00.12	setting relationship selector	8	PID enable	P00.44	A11 high side setting	16	A11 high side set 16kg (0-10V corresponding to 0-16kg)	P00.50	PID proportional gain	0.01%	According to field adjustment (use PID dormancy parameter)	P00.51	PID integral gain	10s	According to field adjustment (use PID dormancy parameter)	P00.54	PID range	16	PID set feedback range 16kg	P00.55	PID dormancy frequency	10%	PID dormancy frequency set 5Hz (maximum default setting value 5Hz)	P00.56	PID dormancy time	5s	PID dormancy time 5s	P00.57	PID wakeup deviation	20%	PID wakeup deviation 20%	P00.58	PID enter wakeup time	10s	PID wakeup time 10s	P00.59	PID dormancy action	2	PID dormancy action set 0: no dormancy	P01.68	display value 1 source	1090	keyboard display PID setting pressure	P01.69	display value 2 source	1091	keyboard display PID feedback pressure	P02.03	UPI command source	1	(UP) command from keyboard	P02.04	DOWN command source	1	(DOWN) command from keyboard	
parameter	parameter name	range	description																																																																								
P01.63	keyboard setting source	0	digital keypad(P02.92)setting																																																																								
P02.92	setting value	10	PID digital keypad set time																																																																								
P00.11	feedback value	2	PID analog A11 feedback																																																																								
P00.12	setting relationship selector	8	PID enable																																																																								
P00.44	A11 high side setting	16	A11 high side set 16kg (0-10V corresponding to 0-16kg)																																																																								
P00.50	PID proportional gain	0.01%	According to field adjustment (use PID dormancy parameter)																																																																								
P00.51	PID integral gain	10s	According to field adjustment (use PID dormancy parameter)																																																																								
P00.54	PID range	16	PID set feedback range 16kg																																																																								
P00.55	PID dormancy frequency	10%	PID dormancy frequency set 5Hz (maximum default setting value 5Hz)																																																																								
P00.56	PID dormancy time	5s	PID dormancy time 5s																																																																								
P00.57	PID wakeup deviation	20%	PID wakeup deviation 20%																																																																								
P00.58	PID enter wakeup time	10s	PID wakeup time 10s																																																																								
P00.59	PID dormancy action	2	PID dormancy action set 0: no dormancy																																																																								
P01.68	display value 1 source	1090	keyboard display PID setting pressure																																																																								
P01.69	display value 2 source	1091	keyboard display PID feedback pressure																																																																								
P02.03	UPI command source	1	(UP) command from keyboard																																																																								
P02.04	DOWN command source	1	(DOWN) command from keyboard																																																																								

Function code	Function	Description(setting range)	Factory default
P00.60	startup function	0:start frequency operation 1:speed start 2:DC injection * principle interpretation: 0: no frequency output startup mode, meet to P00.61 startup time setting, P00.62 start frequency start to startup operation. 1:speed start, search rotating motor speed, smooth start without impact from search speed. 2:DC injection, inverter startup by "DC injection before startup" mode.	0
P00.61	startup time	0.000s-60000.000s principle interpretation: when system startup, setting start function work within setting start time.	0.000s
P00.62	start frequency	0.000Hz-100.000Hz principle interpretation: start function finish, if setting frequency bigger than start frequency, system start from start frequency; if setting frequency smaller than start frequency, system start from setting frequency.	0.000Hz
P00.63	DC injection current	0.000%-200.000% function: set magnitude of DC injection current. (set P00.60=2 as DC injection) * principle interpretation: start mode is DC injection, need to set magnitude of DC braking current, 100% corresponding to inverter rated current.	100.000%
P00.64	stop function	units: 0: free stop; 1: DC braking; tens: 1: accurate stop * principle interpretation: during stop process, stop function starts work when output frequency smaller than stop frequency. accurate stop: stop at any speed motor rotation turns are same, realize consistent repeatability of stop position. To get the best efficiency, deceleration time not to trigger over pressure and over loss rate prevention function as long as possible.	0
P00.65	stop frequency	0.000Hz-1000.000Hz interpretation refer to 0.64	0.000Hz
P00.66	DC braking current	0.000%-300.000% set DC braking current.	100.000%
P00.67	DC braking time	0.000s-1000.000s set DC braking time.	0.000s
P00.68	braking resistor mode	0: invalid 1: valid function: braking resistor braking mode parameter set	1
P00.70	control mode	0:VF 1:vector control 1 function:select motor control algorithm	1
P00.71	carrier frequency	2kHz-16kHz function: set carrier frequency	*kHz
P00.72	motor power	0.000kW-100000.000kW function: set motor parameters	*kW
P00.73	motor voltage	0V-1000V function: set motor parameters	*V
P00.74	motor frequency	1Hz-3000Hz function: set motor parameters	*Hz
P00.75	motor current	0.00A-1000.00A function: set motor parameters	*A
P00.76	motor speed	10rpm-65535rpm function: set motor parameters	*rpm
P00.78	VF curve-F1	0.0Hz-3000.0Hz	50.0Hz
P00.79	VF curve-F2	* principle interpretation: set V/F curve under V/F control mode. When vector control 1 is adopted, set the corresponding frequency points of V/F curve to adjust control characteristics of the corresponding control points.	50.0Hz
P00.80	VF curve-F3		50.0Hz
P00.81	VF curve-F4		50.0Hz
P00.82	VF curve-V0	0V-1000V	0V
P00.83	VF curve-V1	* principle interpretation: set V/F curve under V/F control mode. When vector control 1 is adopted, set the corresponding voltage points of V/F curve to adjust control characteristics of the corresponding control points.	*V
P00.84	VF curve-V2		*V
P00.85	VF curve-V3		*V
P00.86	VF curve-V4		*V
P01.41	local address	0-247 function: set inverter local address	1
P01.42	baud rate	0:2400bps 1:4800bps 2:9600bps 3:19200bps 4:38400bps 5-10:reserved function: Communication port configuration	3

Function code	Function	Description(setting range)	Factory default
P01.43	odd-even check	0:no check 1:even check 2:odd check function: Communication port configuration	0
P01.44	data bits	7-8 function: Communication port configuration	8bits
P01.45	stop bits	0.0-2.0 function: Communication port configuration	1.0bit
P01.47	parameter decimal place mode	0-	