

END COVER COLOR: BLACK

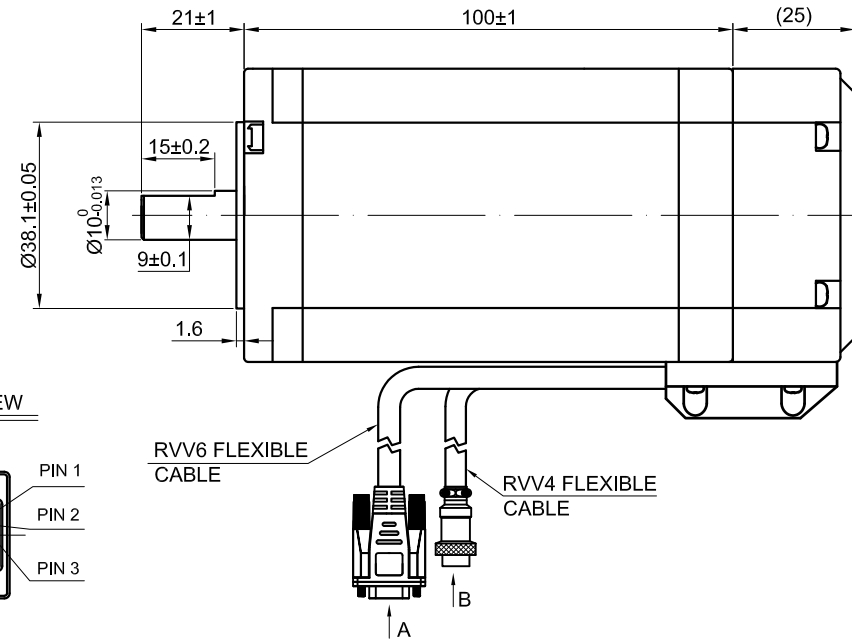
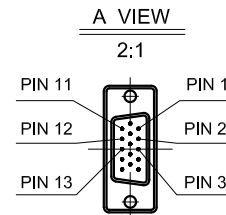
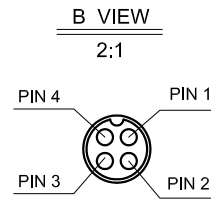
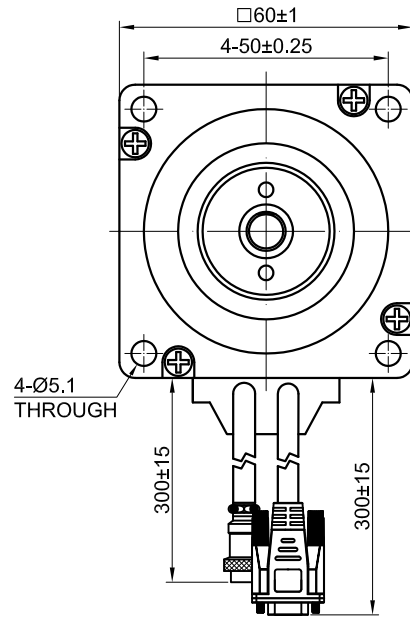

SPECIFICATION	CONNECTION	BIPOLAR
NO. OF PHASE		2
AMPS/PHASE		5.00
RESISTANCE/PHASE(Ohms)@20°C		0.60±10%
INDUCTANCE/PHASE(mH)@1KHz		2.60±20%
HOLDING TORQUE(Nm)[lb-in]		4.00 [35.43]
STEP ANGLE(°)		1.8
STEP ACCURACY(NON-ACCUM)		±5.00%
WEIGHT(Kg)[lb]		—
TEMPERATURE RISE:MAX.80°C ( MOTOR STANDSTILL;FOR 2PHASE ENERGIZED )		
OPERATION AMBIENT TEMPERATURE -10°C~50°C[ 14°F~122°F]		
INSULATION RESISTANCE 100 Mohm (UNDER NORMAL TEMPERATURE AND HUMIDITY)		
INSULATION CLASS B 130°C[266°F]		
DIELECTRIC STRENGTH 500VAC FOR 1MIN.(BETWEEN THE MOTOR COILS AND THE MOTOR CASE)		

TYPE OF CONNECTION (EXTERN)		MOTOR	
PIN NO	BIPOLAR	LEADS	WINDING
1	A —	WHT	A
2	A\ —	GRN	A\
3	B —	BLU	B
4	B\ —	BLK	B\

FULL STEP 2 PHASE-Ex. ,  
WHEN FACING MOUNTING END (X)

STEP	A	B	A\	B\	CCW	CW
1	+	+	-	-	↓	↑
2	-	+	+	-		
3	-	-	+	+		
4	+	-	-	+		

ENCODER RESOLUTION:1000CPR

15-PIN DB MALE PLUG	1	2	3	11	12	13
LEAD COLOR	BLK	RED	WHT	YEL	GRN	BLU
DESCRIPTION	EA+	VCC	GND	EB+	EB-	EA-

	APVD		11.4.2019
	CHKD		
1:1.5	DRN		
SCALE	SIGNATURE		DATE

**STEPPER MOTOR**  
**24HE40-5004D-E1000**